

MIPRO[®]

ACT

ACT 3-Series Diversity Wireless Microphone Systems

User Guide

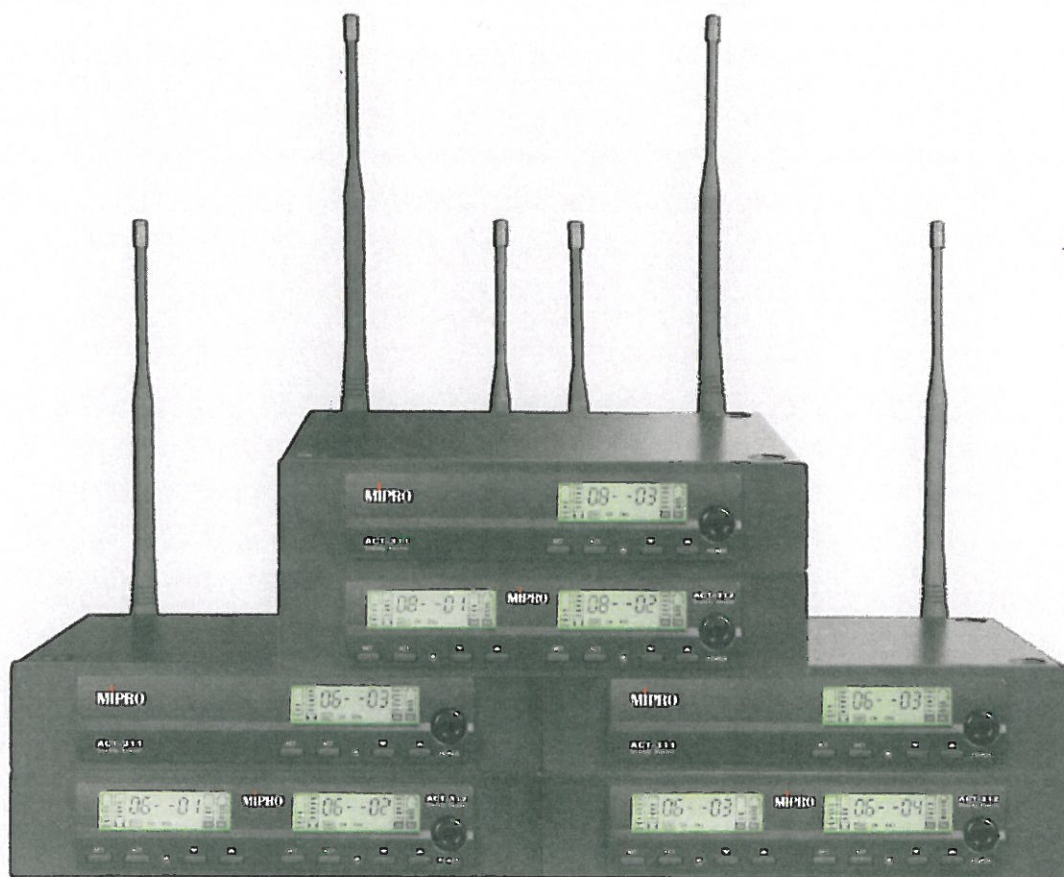

! IMPORTANT SAFETY INSTRUCTIONS !

1. Read these instructions.
2. Keep these instructions.
3. Heed all warnings.
4. Follow all instructions.
5. Do not use this apparatus near water.
6. Clean only with a dry cloth.
7. Do not block any ventilation openings. Install in accordance with the manufacturer's instructions.
8. Do not install near any heat sources such as radiators, heat registers, stoves, or other apparatus (including amplifiers) that produce heat.
9. Do not defeat the safety purpose of the polarised or ground plug: A polarised plug has two blades with one wider than the other. The wide blade is provided for your safety. When the provided plug does not fit into your outlet, consult an electrician for replacement of the obsolete outlet.
10. Protect the power cord from being walked on or pinched particularly at plug, convenience receptacles, and the point where they exit from the apparatus.
11. Only use attachments/accessories specified by the manufacturer.
12. Use only with a cart, stand, tripod, bracket, or table specified by the manufacturer, or sold with the apparatus. When a cart is used, use caution when moving the cart/apparatus combination to avoid injury from tip-over.
13. Unplug this apparatus during lightning storms or when unused for long periods of time.
14. Refer all servicing to qualified service personnel. Servicing is required when the apparatus has been damaged in any way, such as power-supply cord or plug is damaged, liquid has been spilled or objects have fallen into the apparatus, the apparatus has been exposed to rain or moisture, does not operate normally, or has been dropped.
15. To reduce the risk of fire or electric shock, do not expose this apparatus to rain or moisture.
16. Apparatus should not be exposed to dripping or splashing and no objects filled with liquids, should be placed on the apparatus.
17. Use only with the battery which specified by manufacturer.
18. The power supply cord set is to be the main disconnected device.



WARNING

1. **FOR OUTDOOR USE:**



To reduce the risk of fire or electric shock, do not expose this apparatus to rain or moisture.

2. **UNDER WET LOCATION:**

Apparatus should not be exposed to dripping or splashing and no objects filled with liquids, such as vases should be placed on the apparatus.

3. **SERVICE INSTRUCTIONS:**

CAUTION - These servicing instructions are for use by qualified service personnel only. To reduce the risk of electric shock, do not perform any servicing other than that contained in the operating instructions unless you are qualified to do so.

CAUTION
RISK OF ELECTRIC SHOCK
DO NOT OPEN

 This symbol indicates that dangerous voltage constituting a risk of electric shock is present within this unit.

 This symbol indicates that there are important operating and maintenance instructions in the literature accompanying this unit.

FC & IC - ID

THIS DEVICE COMPLIES WITH PART 15 OF THE FCC RULES AND RSS-123 ISSUE2 OF CANADA. OPERATION IS SUBJECT TO THE FOLLOWING TWO CONDITIONS:

(1) This device may not cause interference.

(2) This device must accept any interference, including interference that may cause undesired operation of the device. This equipment complies with FCC RF radiation exposure limits set forth for an uncontrolled environment.

Disposal

Dispose of any unusable devices or batteries responsibly and in accordance with any applicable regulations.



2005-08-13

Disposing of used batteries with domestic waste is to be avoided!

Batteries / NiCad cells often contain heavy metals such as cadmium(Cd), mercury(Hg) and lead(Pb) that makes them unsuitable for disposal with domestic waste. You may return spent batteries/ accumulators free of charge to recycling centres or anywhere else batteries/accumulators are sold.

By doing so, you contribute to the conservation of our environment!

CONTENTS

- 1 Product Overview
- 2 Key Features & Benefits
- 3 MIPRO's Proprietary "ACT" Function & Operation
- 4 Receiver Controls and Indicators - Front Panel
- 5 Receiver LCD Interface
- 6 Receiver Controls and Indicators - Back Panel
- 7 Receiver Installation
- 8 Receiver Operating Tips
- 9 Rackmount Installation for Receivers
- 10 Receiver Parameters
- 16 Dimming & Lit Display Mode
- 17 Wireless Accessories & Replacement Parts
- 18 Set-up Interference-Free Preset Compatible Systems
- 19 General Tips for Improving System Performance
- 20 Troubleshooting

PRODUCT OVERVIEW

MIPRO is a leading manufacturer of truly innovative wireless microphone systems. No other brands can match the easy set-up of MIPRO's industry's first AutoScan and patented ACT (Automatic Channel Targeting) channel sync set-up technology.

MIPRO's ACT systems are built to handle tough conditions, delivering superb RF reliability and transparent audio performance in a wide variety of professional venues and applications.

RECEIVER ACCESSORIES INCLUDED

Detachable 1/2 Wave Antenna x2
(4-pcs for ACT-311T & ACT-312T)

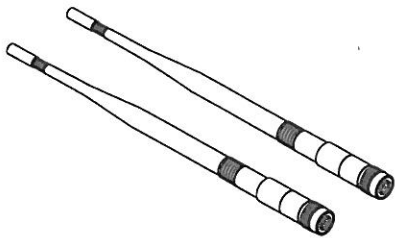

Audio Output Cable x1
(2-pcs for ACT-311T & ACT-312T)

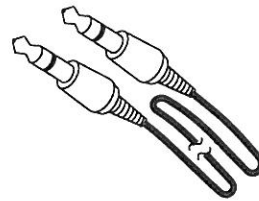

Power Supply with Cable x1

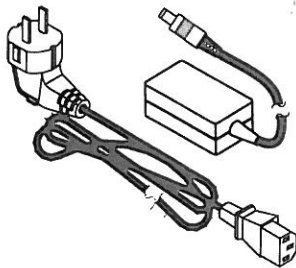

User Guide x1

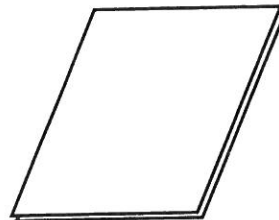

KEY FEATURES AND BENEFITS

- Single, dual & quad channels in EIA standard 1/2 & 1-RU metal housing.
- Diversity technology for optimum reception.
- 961 channels across 24 MHz band. (except EU/ISM 863~865 MHz range)
- Up to 8 preset compatible channels in each band. (except EU/ISM 863~865MHz band)
- One-touch AutoScan for a clear, interference-free receiver frequency.
- MIPRO's patented ACT feature and now, industry standard, facilitates simple frequency synchronization between receiver and transmitter
- Advanced multi-function backlit LCD for clear visibility and displays RF/Audio/transmitter battery/squelch meters; A/B diversity & lock indicators; and Group, Channel and Frequency.
- Programmable Group, Channel, Frequency, Squelch and Lock functions.
- Automatic brightness display during performance and idle.
- Dual "PiloTone & NoiseLock" circuits minimize interference.
- All parameters easily monitored in a single display for easy control and monitoring.
- The receiver panel controls can be locked to prevent accidental changing of settings.
- Industry's only interference 'warning' indicator and control to manage it.
- Detachable antennas for front or rear panel installation.
- Receiver provides bias voltage for MIPRO antenna booster systems.
- Balanced XLR & unbalanced 1/4" audio outputs.

MIPRO'S PROPRIETARY "ACT" FUNCTION & OPERATION

What is ACT?

'ACT' stands for 'Automatic Channel Targeting'. MIPRO developed and patented this innovative infrared (IR) sync technology in 2001. MIPRO was the first manufacturer in the industry to automatically synchronize the frequency selected on the receiver to any ACT handheld or bodypack transmitter on the same frequency band.

ACT Benefits:

- No manual frequency adjusting needed, unlike traditional transmitters.
- Simple, fast and precise frequency set-up without mechanical errors.
- Once the frequency has been set, the data is stored in memory, meaning that the frequency is set until it is changed by performing the 'ACT' function again, even after powering off.

ACT Set-Up

- Ensure a receiver channel is set-up and transmitter batteries are fresh, installed correctly and powered-on.
- Press the ACT button on the receiver to activate the ACT syncing function. Once activated, the group/channel and working frequency start blinking.
- Bring ACT handheld or bodypack transmitter within 30cm (12") of the IR port on the receiver. The IR port is located between the 'ACT' and "▼" buttons and indicated by a round-shaped red color spot. The frequency will sync automatically.
- When the frequencies are synchronized successfully between the receiver and transmitter, the RF meter cursor and working frequency stop blinking and the indicators in the RF meter are lit.

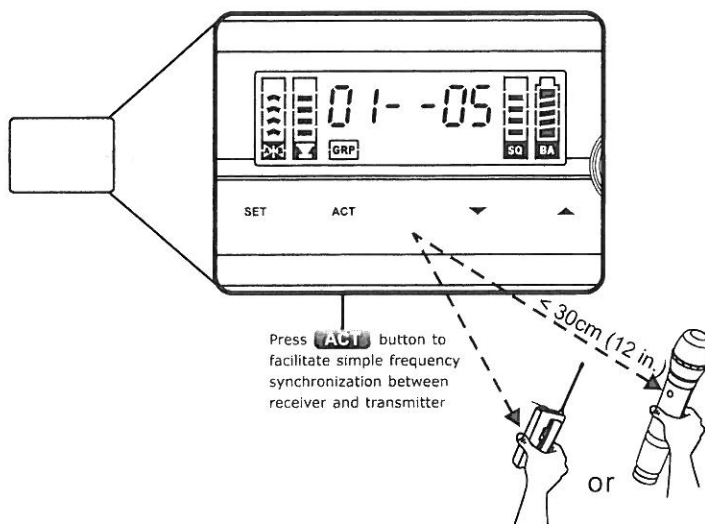

RECEIVER CONTROLS AND INDICATORS

Front Panel

ACT-311 Single Channel

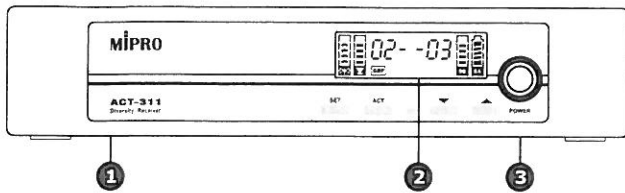

ACT-312 Dual Channel

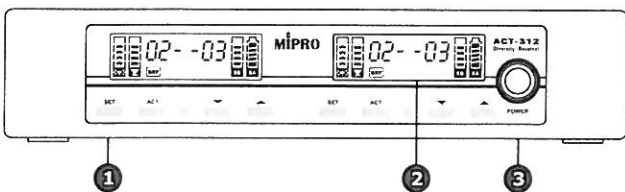

ACT-311T Dual Channel

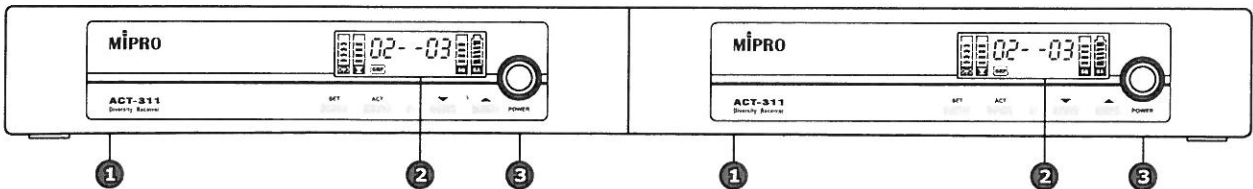

ACT-312T Quad Channel

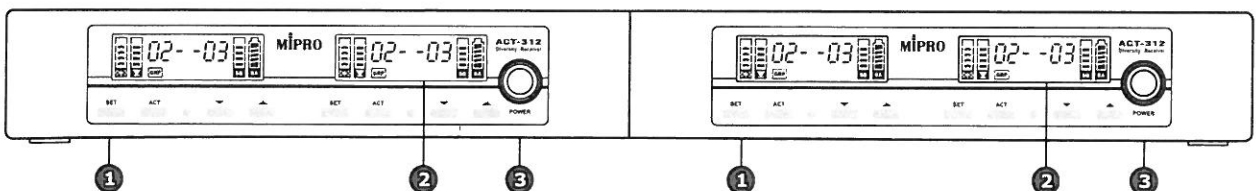

(Figure 1)

- ① **Receiver Panel:** LCD screen and control buttons.
- ② **Receiver Display:** LCD screen.
- ③ **Power On/Off Button:** Press and hold button to turn the receiver on and off.

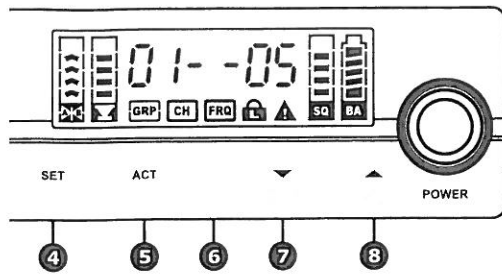

- ④ **SET button:** To set receiver parameter values like group, channel, frequency, squelch and lock.
- ⑤ **ACT button:** Facilitates simple frequency synchronization (sync) between receiver and transmitter.
- ⑥ **ACT sync port:** Align IR sync ports of both receiver and transmitter for successful frequency synchronization after ACT button is pressed.
- ⑦ **▼ Button:** Decrease parameter value.
- ⑧ **▲ Button:** Increase parameter value.

RECEIVER LCD INTERFACE

Displays all Parameters

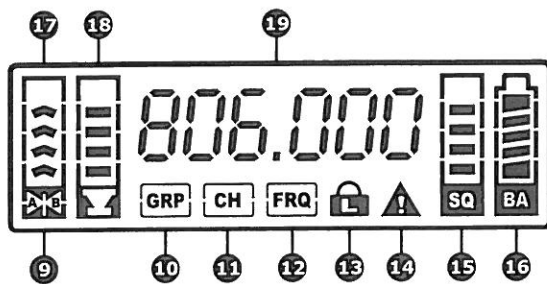

- ⑨ **Antenna A/B reception indicator.**
- ⑩ **GRP Group icon.**
- ⑪ **CH Channel icon.**
- ⑫ **FRQ Frequency icon.**
- ⑬ **Lock mode icon: Locked (lit).**
- ⑭ **Interference warning icon (lit).**
- ⑮ **SQ Squelch Level:** Indicate Sensitivity Level.
- ⑯ **Transmitter Battery Level:** Indicate current transmitter battery level.
- ⑰ **RF Signal Level:** Indicate RF signal strength from the transmitter.
- ⑱ **Audio Signal Level:** Indicate audio signal strength from transmitter.
- ⑲ **Channel & Frequency Display:** Display Group/Channel & Frequency.

RECEIVER CONTROLS AND INDICATORS

Rear Panel

ACT-311 Single Channel

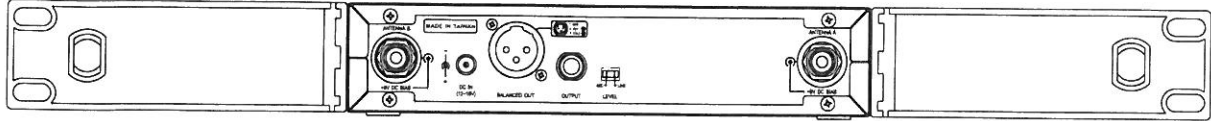

ACT-312 Dual Channel

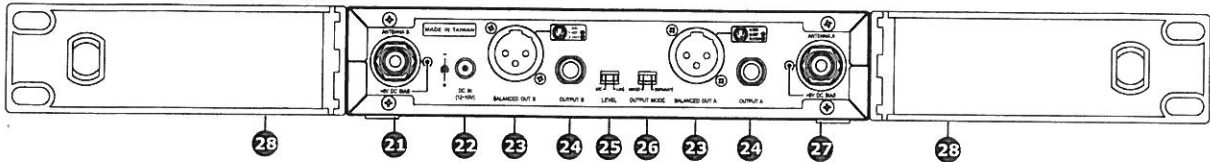

ACT-311T Dual Channel

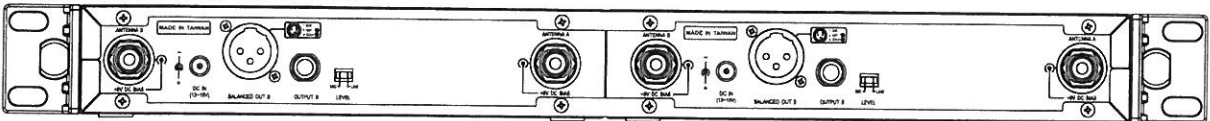

ACT-312T Quad Channel

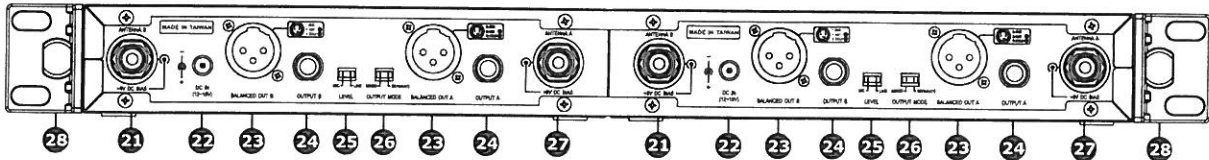

(Figure 2)

- ②① **Rear Antenna 'B' Input Connector:** The 'B' antenna can be installed directly to this antenna connector which also provides power to an optional antenna booster.
- ②② **DC Input Jack:** Accepts +12V DC to +15V DC (center pin is positive and sleeve is ground).
- ②③ **Balanced Audio Output Jack:** XLR type connector provides balanced audio output signal from this jack to the mixer.
- ②④ **Unbalanced Audio Output Jack:** 6.3mm (1/4") phone-jack type connector provides unbalanced audio output signal from this jack to the mixer. Selectable: Mic or Line.
- ②⑤ **Unbalanced Output Switch:** MIC level is microphone output level (0dB). LINE level is auxiliary output.
- ②⑥ **Mixed and Separate Output Switch :** Switch to "MIXED" mode, audio from both channels will be mixed out from BALANCED OUTPUT B ②③ and UNBALANCED OUTPUT B ②④ . Switching to "SEPARATE" mode (available in dual & quad channels only) and each channel has individual output.
- ②⑦ **Rear Antenna 'A' Input Connector:** The 'A' antenna can be installed directly to this antenna connector which also provides power to an optional antenna booster.
- ②⑧ **Rack-Mount Brackets:** Fits into a standard 19-inch rack case.

Optional MIPRO FBC-71 rear-to-front cables can be installed for front antenna placement to improve reception quality.

RECEIVER INSTALLATION

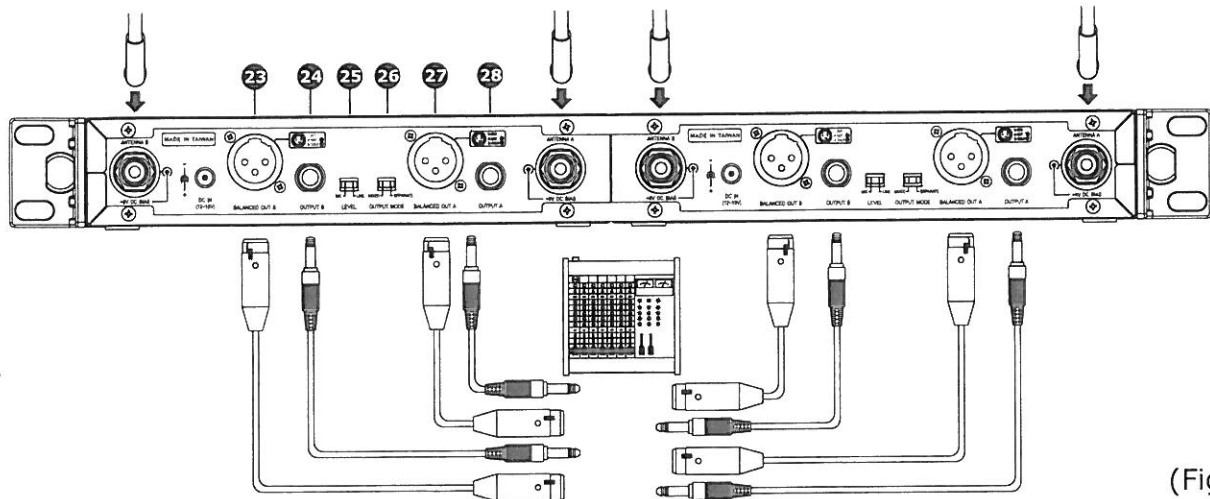

(Figure 3)

Antenna Installation:

- Install 2 separate antennas on the antenna sockets 21 27 on the rear panel. illustrated in Figure 3.

Audio Output Connection:

Level Switch Setting Position for Unbalanced Output 25 :

- When connecting from receiver's unbalanced output to the "AUX-IN" jack of a mixer or amplifier or "Electric Guitar", switch the Level Switch to " **LINE** " position. Low sensitivity may occur if switch to the wrong level position. When connecting from receiver's unbalanced output to the "**MIKE IN**" jack of a mixer or amplifier; switch the Level Switch to " **MIC** " position. Louder or quieter volume of microphone may occur if switch to the wrong level position. When using electric guitar, don't use " **MIC** " position as it may have generated insufficient level.

Connection Method of Unbalanced Output:

- When receiver and mixer/amplifier is under short distance. Or the connectors of receiver/mixer/amplifier are "PHONE" types. Using audio output cable attached with "PHONE PLUG" type, connect one end from the unbalanced output jack 24 , of the receiver, and the other end to the "LINE-IN" input jack of the mixer/amplifier, as shown in Figure 3.

Connection Method of Balanced Output:

- When receiver and mixer/amplifier is under long distance. Or the connectors of receiver/mixer/amplifier are "XLR" types. Using audio output cables with "XLR" or "Cannon" type connectors, connect one end to the balanced output jacks 23 , of the receiver, and the other end to the "**MIKE IN**" input jack of the mixer or amplifier, as shown in Figure 3. (The configuration of the 3-pin connector is as shown in Figure 5.

Electrical Guitar Output:

- Using audio output cable attached with "PHONE PLUG" type, plug one end from the balanced output jack of a receiver, and the other end to the input jack of a guitar amplifier. Switch the Level Switch " **LINE** " position.

Connecting the power supply:

- Plug DC plug into the DC-input jack  and the power cord, into a power outlet.

Antenna Inputs:

- The antenna inputs provide 8-volt DC biased and are designed to work with MIPRO antenna boosters. If the connecting cable is longer than 10 meters (approx. 30'), it is advisable to install an antenna booster to ensure optimal reception.

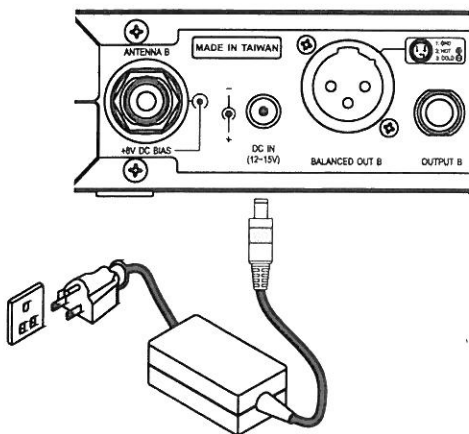

(Figure 4)

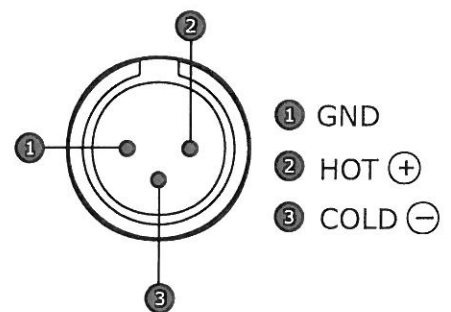

(Figure 5)

RECEIVER OPERATING TIPS

- Prior to powering on the receiver, ensure all transmitters are turned off and the mixer's volume control is set to a minimized setting.
- Normally, the RF meter level glows when a transmitter is powered on to indicate the receiver is ready for operation. Once an audio signal is received from the transmitter, the AF (audio) meter level glows based on signal strength. If the meter or indicator does not glow or there is no audio output, the system may not be set up properly. Re-check that the transmitter is turned on and the receiver and transmitter are on the same frequency (if not, the transmitter will need to be reset via the ACT function).
- The microphone output level needs to be adjusted at the amplifier or mixer. There is no need to adjust output levels at the receiver itself.
- Antenna dividers and receivers must be from the same frequency band.

RACKMOUNT INSTALLATION FOR RECEIVERS

Half-Rack Unit Receiver

- Install the optional FB-71 rackmount kit & fasten with screws on both sides. (Figure 6)

1-Rack Unit Receiver

- Install the optional FB-72 rackmount kit & fasten with screws on both sides. (Figure 7)

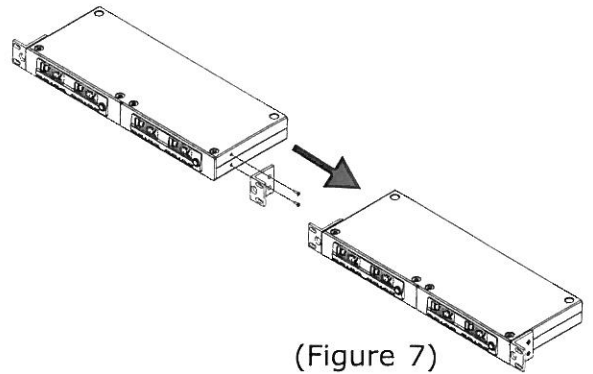
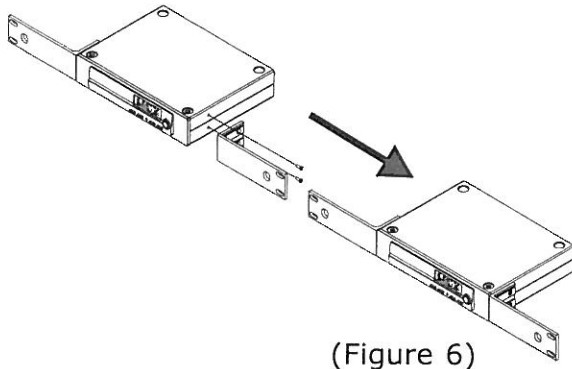

RECEIVER RACK-MOUNT KITS

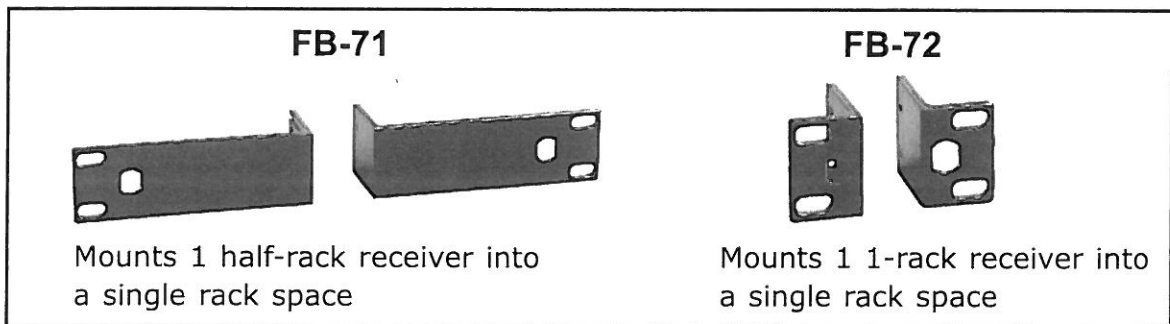

- The rack mountable kits are pre-drilled with 4 opening holes to be fitted on an EIA standard 19-inch rack case. (Figure 8)
- For ideal reception and performance, install the receiver at least 1 meter (3 feet) above the ground and away from EMI / RFI "noise" sources. In addition, place the transmitter/microphone at least 1 meter (3 feet) away from the receiving antenna, as shown. (Figure 9)

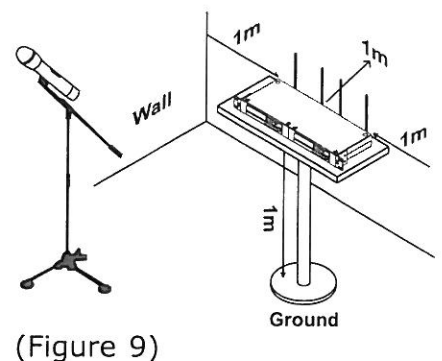
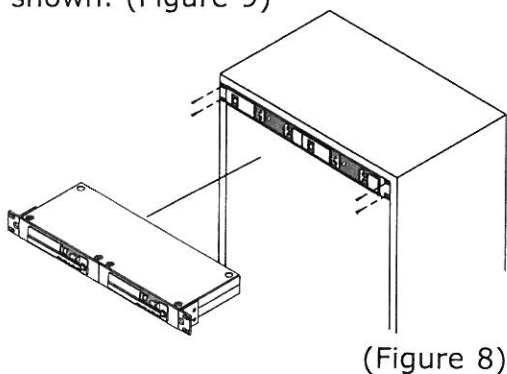

LCD SCREEN DISPLAYS ALL PARAMETER VALUES

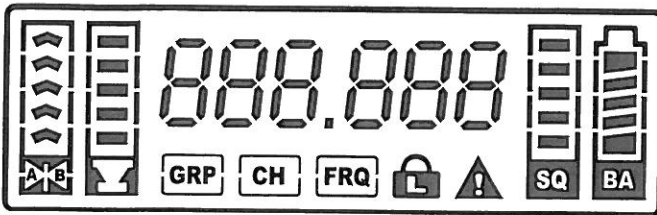

RECEIVER PARAMETERS

4 receiver parameters can be selected and programmed using the **SET** button.

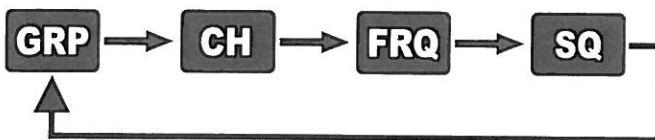

GRP Group

CH Channel

FRQ Frequency

SQ Squelch

GRP GROUP setting

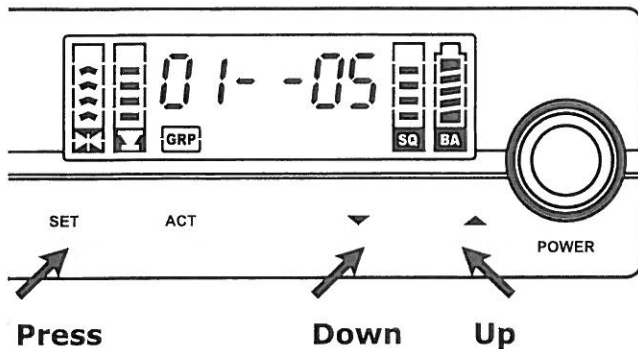

Instructions:

1. Press and release the **SET** button until both **GRP** cursor and group number start to blink denoting it is ready to accept parameter changes.
2. During blinking, press ▼ or ▲ button to one of the 7 factory preset groups.
3. **EU/ISM 863-865MHz Band:** During blinking, press ▼ or ▲ button to one of the 2 factory preset groups. Group 1 has 4 preset compatible channels. Group 2 has the user-defined channels.
4. Press the **SET** button to confirm the change.

To exit **GRP** mode:

- GRP mode deactivates if ▼ or ▲ button is not pressed within 5 seconds and LCD screen dims if not pressed in 10 seconds.

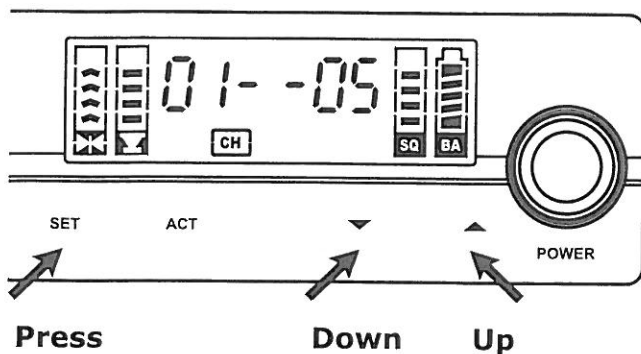
CH CHANNEL setting**Instructions:**

1. Press and release the **SET** button until both **CH** cursor and channel number start to blink denoting it is ready to accept parameter changes.
2. During blinking, press and release ▼ or ▲ button to autoscan and autostop for a clear, interference-free preset channels.
or
During blinking, press and hold ▼ or ▲ button to stop one of the 8 factory preset channels.
3. EU/ISM 863-865MHz Band: In Group 1, during blinking, press and release ▼ or ▲ button to autoscan and autostop for a clear, interference-free preset compatible channels.
4. Press the **SET** button to confirm the change.

To exit CH mode:

- CH mode deactivates if ▼ or ▲ button is not pressed within 5 seconds and LCD screen dims if not pressed in 10 seconds.

FRQ User-Defined FREQUENCY Setting

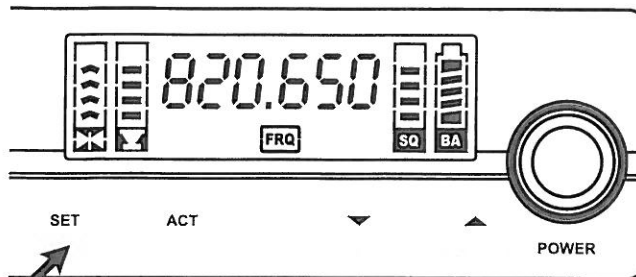

Press

Instructions:

NOTES:

- (1) 961 frequencies can be user-defined and up to 8 frequencies can be stored in Group 7.**
- (2) EU/ISM band: Up to 4 frequencies can be stored in Group 2.**

1. Press and release the **SET** button until both **GRP** icon and group number start to blink.
2. During blinking, press and release **▼** or **▲** button to group 7.
3. Press the **SET** button until it stops at FRQ cursor.
4. Press **SET** button again until the first 3 digit of frequency starts to blink denoting FRQ it is ready to accept parameter changes.
5. During blinking, press **▼** or **▲** button to decrease or increase parameter value by 1MHz.
6. Press the **SET** button to confirm the change. Once change is saved, the last 3 digits of the frequency starts to blink.
7. During blinking, press **▼** or **▲** button to decrease or increase parameter value by 25KHz.
8. Press the **SET** button to confirm the change.
9. Up to 8 different frequencies can stored in Group 7- - 01 to 08.
10. Up to 4 different frequencies can stored in Group 2- - 01 to 08 (EU/ISM Band).

Caution:

The 8 saved frequencies in group 7 and 4 saved frequencies in group 2 (EU/ISM 863-865MHz) may not be compatible and interference-free and therefore, not recommended to be used simultaneously at the same venue.

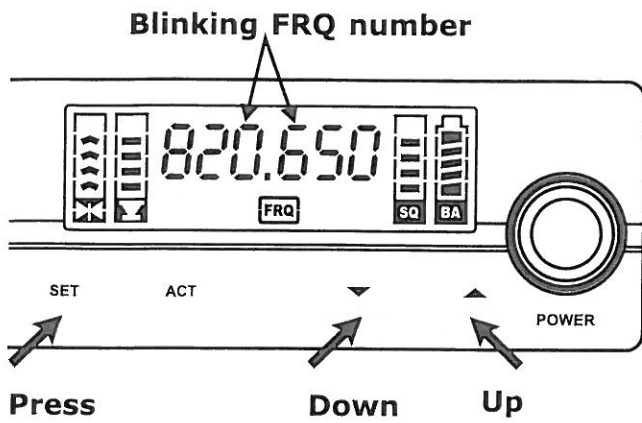
FRQ User-Defined FREQUENCY Setting**To exit **FRQ** mode:**

- FRQ mode deactivates if ▼ or ▲ button is not pressed within 5 seconds and LCD screen dims if not pressed in 10 seconds.

SQ SQUELCH Setting

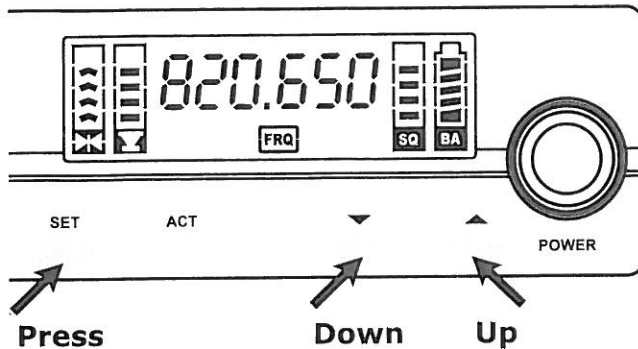

Instructions:

1. Press and release the **SET** button until **SQ** cursor starts to blink denoting it is ready to accept parameter changes.
2. During blinking, press and release ▼ or ▲ button to decrease or increase the squelch level.
3. Press the **SET** button to confirm the change.

WARNINGS:

- Decreased SQ level setting has higher sensitivity level resulting in longer, maximize reception range.
- Increased SQ level setting has lower sensitivity level resulting in shorter, limited reception range.

To exit **SQ mode:**

- SQ mode deactivates if any button is not pressed within 5 seconds and LCD screen dims if not pressed in 10 seconds.

LOCK Setting

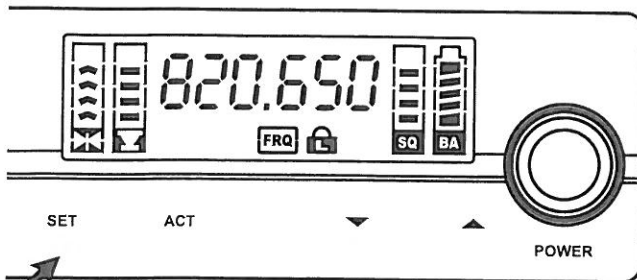

Press

Instructions:

The purpose of Lock function is to lock and prevent accidental changing of settings.

To Lock setting:

- Press and hold the **SET** button for approximately 3 seconds until the Lock icon appears.

To Unlock setting:

- Press and hold the **SET** button for approximately 3 seconds until the Lock icon disappears.

Dimming & Lit Display Mode

- The receiver LCD screen will dim automatically if no transmitting signals are received or **SET** **ACT** button is not pressed within 5 seconds.
- **Lit LCD Screen Continuously:**
Press and hold **▲** button for approx. 2 seconds will force the screen to be lit continuously.
- **Cancel Lit LCD Screen Continuously:**
Press and hold **▲** button for approx. 2 seconds will cancel it.

BA: Transmitter Battery Level

Battery Status:

- The battery meter is lit when the transmitter is powered on. The battery meter gives a percentage (%) indication of remaining battery life, as shown. Replace with new, fresh batteries when battery indicators fall to 10% (1 indicator remaining).
- The **BA** battery cursor starts blinking when transmitter is powered-on and signal is received. After 3~5 seconds, the cursor will stop blinking and accurate battery level will be displayed.

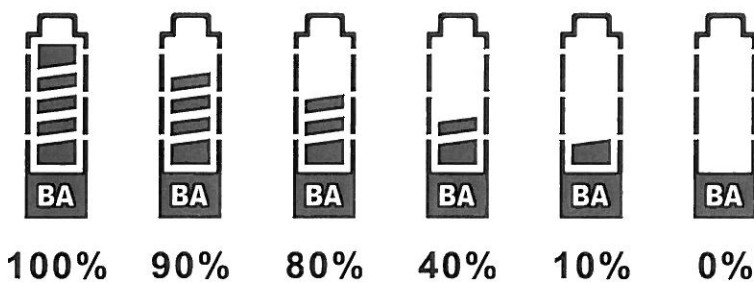

WIRELESS ACCESSORIES & REPLACEMENT PARTS

FB-71: Rackmount kit fits 1 ACT-311 or ACT-312 receiver alone.

FB-72: Rackmount kit fits 1 ACT-311T or ACT-312T receiver alone.

FBC-71: Rear-to-front cables only(1-pair). It allows front mount antenna placement for improved reception quality.

AT-20: Detachable 1/2 Wave Coaxial Antenna.

AD-707a: UHF 4-channel Wideband Antenna Divider System (480MHz ~ 1GHz).

AD-90w: UHF Wideband Directional Antenna (480MHz ~ 1GHz).

AT-70: UHF Ground Plane Antenna (1-pc, 2-pcs recommended)

AT-70B: UHF Antenna Signal Booster (1-pc, 2-pcs recommended)

AD-90S: UHF 4-Channel Wideband Power Splitter.

AT-90A: UHF 4-Channel Wideband Power Amplifier.

AD-808: UHF 4-Channel Active Antenna Combiner.

SETUP INTERFERENCE-FREE PRESET COMPATIBLE SYSTEMS

For up to 8 compatible systems (8 channels can be operated together):

The manufacturer recommends in using all the 8 factory preset channels found in groups 1, 2, 3, 4, 5 or 6. There are no restrictions regarding the minimum safe distance needed between the transmitters and the receivers.

1. To set up multi-channel operation, the user must select factory preset channels within the same group. A combination of preset channels under different groups can result in possible interference.
2. When preset channels (Channels 1,2,3, etc.) within the same group experience interference and cannot work together, it is highly recommended to change to another set of preset channels in a different group.
3. If interference persists in all groups within the chosen frequency band, changing to another frequency band may be recommended. Please contact your local representative or manufacturer for technical assistance.

* **EU/ISM 863-865MHz Band:** 4 preset compatible channels are found in Group 1. Group 2 contains user-defined channels only.

NOTE:

The factory preset interference-free channels are designed for MIPRO ACT 3-series receivers only. Do not mix and use simultaneously with wireless microphone systems from other brands to avoid potential interferences.

GENERAL TIPS FOR IMPROVING SYSTEM PERFORMANCE

1. Since the installation of the antenna influences the operating efficiency of the receiver, the most important rule is to minimize the distance as much as possible between the receiving antenna and the microphone for the best reception and performance.
2. Use MIPRO supplied antennas to ensure proper receiver sensitivity. The external DC power supply should not fall under 12V, otherwise it would not work properly. If it is over 15V, some components of the receiver will be damaged.
3. The antenna socket provides an 8V DC biased output. RF shorting on the antenna socket should be avoided. Temporary shorting on the antenna socket will not affect system performance; however, continuous shorting on the antenna socket will cause permanent system damage.
4. If extended reception distance is needed, installing a MIPRO AT-90W directional antenna kit, which includes internal boosters will increase the reception distance.
5. Proper antenna distribution is vital to achieving ideal performance from multiple wireless systems operating in the same venue. To greatly reduce antenna clutter in multi-system installations, a MIPRO AD-707a, UHF antenna divider system is recommended. Each AD-707a supports up to four UHF diversity receivers to operate from a single pair of antennas. When combined with an AT-70A omni-directional extension antenna and an AT-70B antenna booster or an AT-90W wide-band directional antenna, the AD-707a antenna divider provides optimal signal reception with minimal dropouts or interference.
6. MIPRO's factory preset Interference-free channels within the same channel group are recommended to ensure optimum performance from multiple wireless systems installed in the same venue. Use of preset Interference-free channels from different channel groups may cause interference, thus is not recommended.

TROUBLESHOOTING

Symptom	Solutions
No Sound	<ul style="list-style-type: none"> • Power-on receiver & transmitter. • Receiver is plugged into a power outlet and cable connected to mixer/amplifier. • Fresh batteries in transmitter and inserted with correct polarity. • Match receiver & transmitter frequency.
Signal Drop-outs	<ul style="list-style-type: none"> • Close proximity between the transmitter and receiver antenna. • Line-of-sight path between the transmitter and receiver antenna. • Reposition the receiver and/or receiver antennas. • Receiver antennas are connected. • Elevate receiver antennas as high as possible. • Keep hands off of the transmitter antenna.
Limited Range	<ul style="list-style-type: none"> • Close proximity between the transmitter and receiver antenna. • Adjust antenna orientation. • Reposition the receiver and/or receiver antennas. • Receiver antennas are connected. • Undamaged antennas. • Fresh batteries in transmitter. • Adjust for proper squelch level setting.
No RF Signal	<ul style="list-style-type: none"> • Match receiver & transmitter frequency. • Adjust for proper squelch level setting.
Distortion	<ul style="list-style-type: none"> • Reduce transmitter gain, if set too high. • Recommendation: set to 0dB (Mic Level). • Reduce receiver output setting. • Proper setting on mixer input gain or integrated amplifier mic level control. • Fresh batteries in transmitter.

Symptom	Solutions
RF Interference	<ul style="list-style-type: none"> • Press AutoScan button to locate a clear, interference-free channel. • Use preset compatible channels in the same group when operating multiple systems. • Place receivers away or remove the sources of RF interference like solid metal objects, electronic equipment & digital devices, dimmers, effect equipment, motors. • Avoid operating a frequency on a local TV channel. • A higher squelch setting improves protection against interference. (however, resulting in limited range) • Turn off one transmitter, if both transmitters are operating on the same frequency. • Fresh batteries in transmitter.
Feedback	<ul style="list-style-type: none"> • Turn down the sound system volume. • Move microphone closer to the performer's mouth. • Reduce transmitter gain if set too high. • Position microphone further away from the speakers. Do not point towards speakers. • Use right type of microphone for the specific applications. Uni/Omni, Supercardioid / Cardioid. • Power off all unused microphones.